

# “BIG BUG BLASTER!”



## GAME OPERATION & INSTRUCTION MANUAL

FOR ALL PARTS, SERVICE, AND TECHNICAL SUPPORT

PHONE: 708-598-3720 FAX: 708-598-3720 [WWW.FAMILYFUNCOMPANIES.COM](http://WWW.FAMILYFUNCOMPANIES.COM)

STING INTERNATIONAL, © 2018 ALL RIGHTS RESERVED



**“BIG BUG BLASTER” REAR VIEW**

THIS GAME IS INTENDED FOR INDOOR USE ONLY

# CONTENTS

1. SPECIFICATION .....	1
2. INTRODUCTION .....	1
2-1 OVERVIEW .....	1
2-2 IMPORTANT SAFETY INFORMATION .....	2
2-3 SET UP .....	2
3. PACKAGE CONTENTS .....	3
4. INSTALLATION .....	3
4-1 LOCATIONS TO AVOID .....	3
4-2 INSTALLING ON SITE .....	4
5. CONNECTING THE POWER CORD .....	5
5-1 POWER RECEPTICAL .....	5
6. PARTS DESCRIPTION .....	6
6-1 GAME APPEARANCE AND FEATURES .....	6
6-2 CONTROL PANEL CONSOLE .....	7
6-2 TICKET MECHANISM (ENTROPY) .....	8
6-4 COIN MECH TW-130B .....	9
6-6 HOST PC and I/O .....	10
7. CONTROL SIGNAL AND INSTRUCTION .....	11
7-1 PCB LAYOUT .....	11
7-2 HOW TO ENTER INTO MENUS .....	15
8. INSTRUCTION OF GAME PLAY .....	19
9. GENERAL TROUBLESHOOTING .....	23
10. PART LIST .....	25
11. REMOVING THE FIBERGLASS BODY .....	37

# 1. SPECIFICATION

(1) Dimension: D 75.35", W 41.50", H 48.39" (D1914mm, W1054mm, H1229mm)

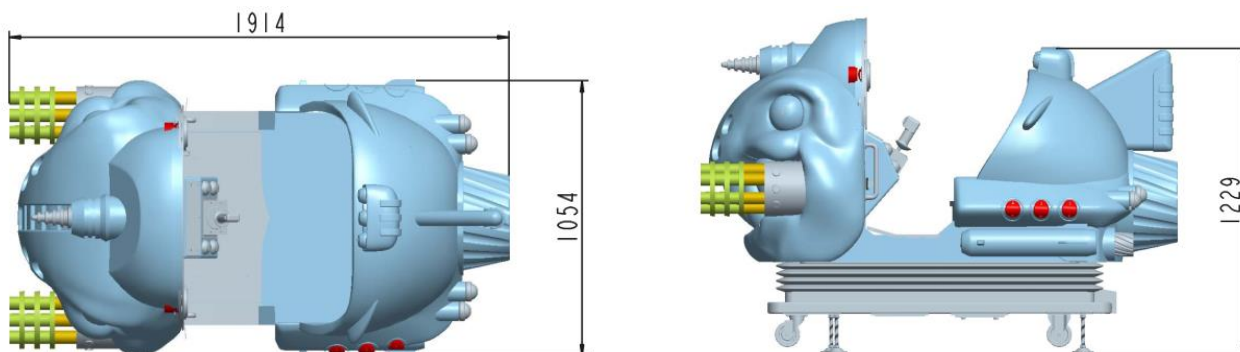

(2) Weight: 397 LBS. (180 KG)

(3) Voltage: AC 110V -120V, 60Hz ; or; Euro 220-240V , 50Hz-;

(4) Power: 100W-500W (in operation, based on load, the higher the power required)

**Note: Please refer to the nameplate at the back of game for the actual voltage**

(5) Environment: (indoor) temperature; 14°F ~ 104°F (-10°C ~ +40°C); humidity ≤90%

**Note: Game parameters are subject to change without notice.**

## 2. INTRODUCTION

### 2-1 OVERVIEW

Thank you for purchasing the "BIG BUG BLASTER" video game ride.

This owner's Manual is intended to provide detailed descriptions together with all the necessary information regarding the general operation of electronic assemblies, servicing control, spare parts, etc., pertaining to the game.

This manual is intended for the owner, operator, personnel and managers in charge of operation of the product. Operate the product after carefully reading and sufficiently understanding the instructions. If the product fails to function satisfactorily, non-technical personnel should under no circumstances attempt to service the internal system.

### To Maintain Safety:

To ensure the safe usage of the product, be sure to read the following before using the product. The following instructions are intended for the users, operators and the personnel in charge of the operation of the product. After carefully reading and sufficiently understanding the warning display and cautions, handle the product appropriately. Be sure to keep this operation manual nearby the product or elsewhere convenient for referring to it when necessary.

For the safe usage of the product, the following pictographs are used:



Indicates: "HANDLE WITH CARE". In order to protect the human body and equipment, this display is attached to places where the instruction manual should be referred to.



Indicates: a "PROTECTIVE EARTH TERMINAL". Before operating the equipment, be sure to connect it to the ground. (The step may be omitted for products in which a power cable with earth is used.)

↓ Be sure to understand the contents of the displays before operating the equipment or reading the text.



**DANGER**

Indicates that mishandling the product by disregarding this pictograph may cause severe injury or even death.



**WARNING**

Indicates that mishandling the product by disregarding this warning may cause a potentially hazardous situation which can result in death or serious injury.



**CAUTION**

Indicates that mishandling the product by disregarding this caution may cause a slight hazardous situation which can result in personal injury and/or material damage.

## 2-2 IMPORTANT SAFETY INFORMATION

- Unplug the game from the AC wall receptacle when servicing this product. Failure to do so could result in serious injury to yourself or others.
- Use only a GROUNDED AC receptacle. Failure to do so could result in improper operation or damage to the game and could void your warranty. If you are unsure that your AC receptacle is properly grounded, have a qualified electrician perform this check for you.
- Always be sure power to the game is turned off when doing even routine maintenance otherwise, moving parts could activate unexpectedly causing injury.
- This product is heavy, necessitated by the design. When moving this game, be sure you have adequate help. Use a suitable dolly or hand truck where practical.

## 2-3 SET UP





- Be sure that the game is on a level surface. If the game is rocking unevenly on the floor adjust the legs to remove the rocking of the game.
- Be sure to plug the game into the proper A.C. GROUNDED receptacle. Do not use long extension cords unless absolutely necessary and if so, be sure it is a heavy duty cord of at least 16 Ga. and no longer than 20 ft. Check the label on the back of the game to make sure the power requirements of the game match that of your location.
- Turn the game on and check to be sure there are no unusual sounds and that everything appears to be working correctly

### 3. PACKAGE CONTENTS

Be sure to check that you have received all packages indicated below.

☞ **Game Unit**

☞ **Accessories**

No.	Name	Specification	Picture	Qty.	Remark
1	Manual			1	English version
2	Key	GUO711		2	Ticket/DBV door、 coin door、 coin box、 monitor/PC service door
3	Power cord	UL/CE Version		1	Per request
4	Fuse	10A		1	10A For 110V ;
		6.3A		1	6.3A For 220V

### 4. INSTALLATION

Check the parts list before installation. Verify that all parts that have been received and are in good condition

**⚠ ATTENTION**  
For indoor use only!

#### 4-1 LOCATIONS TO AVOID

**⚠ WARNING**

The machine is designed for indoor use only. Never install this machine outdoors or in any of the following:

- Locations exposed to direct sunlight
- Locations subject to rain or water leakage.
- Unstable locations or locations subject to vibration.
- Dusty, hot, or damp locations.

## 4-2 INSTALLING ON SITE

The machine must be fixed on level ground. The product is equipped with 4 casters and 4 adjusters. When installation position /site has been determined, have the adjusters come in direct contact with the floor.

Establish a gap of about 5 mm between the floor and the casters and adjust the unit so that it will remain level.

- ① Move the product to the installation site.
- ② Bring the adjusters into direct contact with the floor. Use a wrench to align the height of the adjusters until the cabinet is perfectly level.

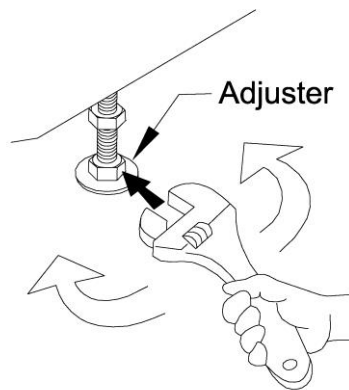

- ③ After setting, turn adjuster nuts upwards to tighten them and secure adjuster heights.

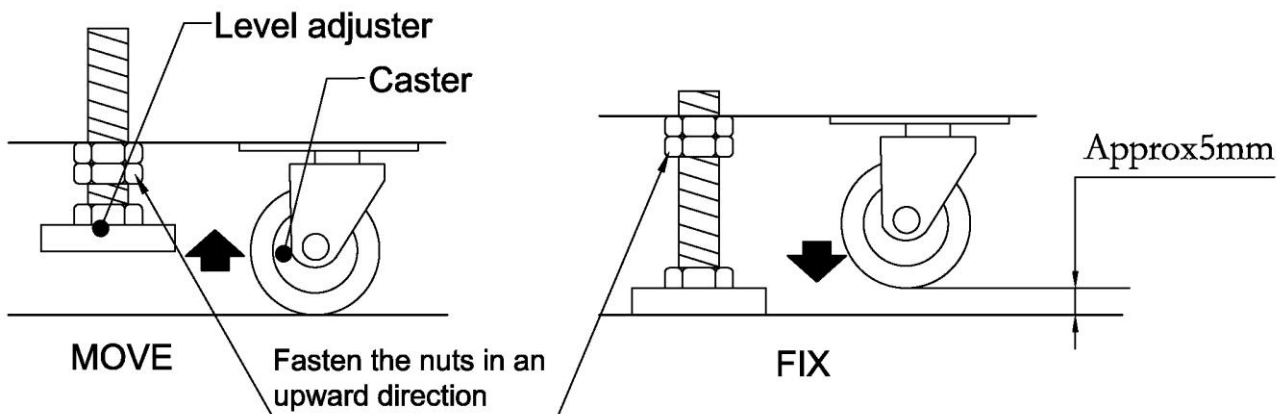

### ⚠ WARNING

- Disconnect game power before moving.
- Make sure all wheels are intact. Replace any wheels that are damaged or broken before moving the game.
- When moving the game, **DO NOT** slide the game across the floor.
- Ensure the game is level before connecting the power.
- To insure a long life of your product we recommend always wrapping the game with soft blankets for moving long distance to protect the finish.

## 5. CONNECTING THE POWER CORD

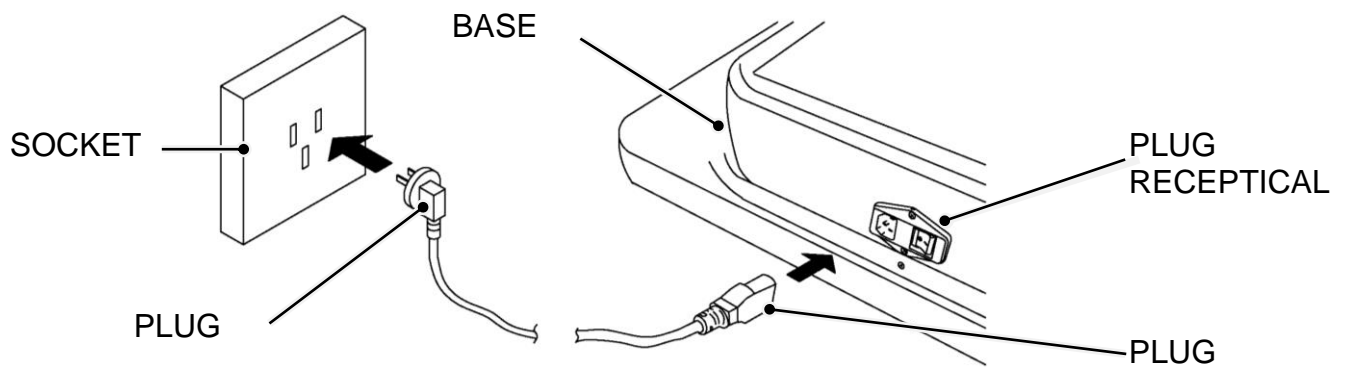

### 5-1 PLUG RECEPTICAL

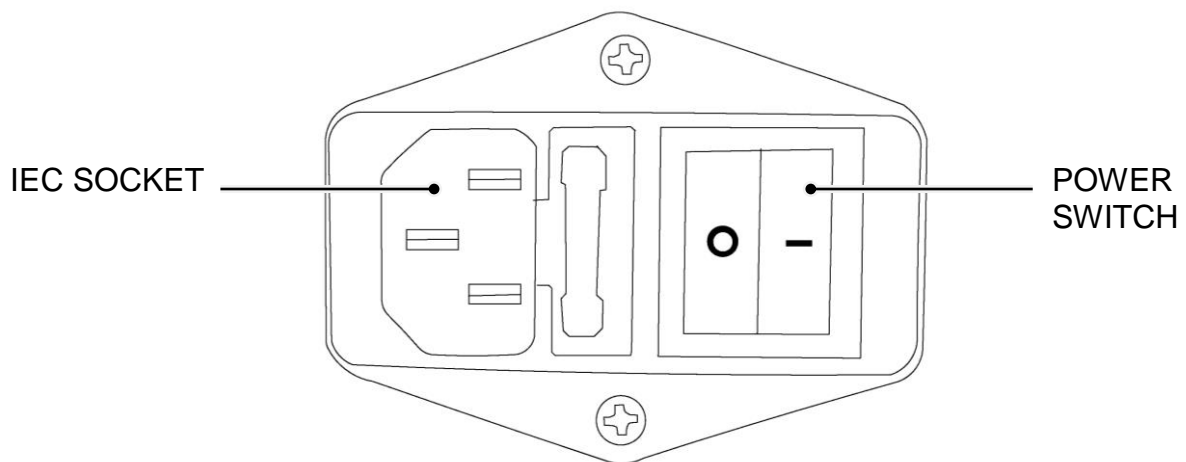

### **!** WARNING

- Do not put heavy items on power cord.

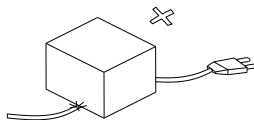

- Hold the power plug instead of the wire to draw the power cord out of the socket.

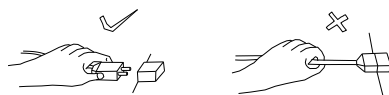

- Do not touch the power plug with wet hands.



- Do not draw or twist the cord or store near any high heat source.

- Do not place the cord where the player can easily trip over, or come in contact with it.



- Operate this game with the correct power and fuse configuration.

## 6. PARTS DESCRIPTION

### 6-1 GAME APPEARANCE AND FEATURES



- 1. BASE FRAME:** Mechanical base below motion cabinet body.
- 2. SAFETY SKIRT:** Keeps hands and feet away from the cabinet body base mechanism in order to protect players. Fiber Reinforced Plastic attaches between cabinet body and base.
- 3. “BIG BUG BLASTER”** Fiberglass body.

4. **MONITOR FRAME – PC and I/O ACCESS:** Opens from the bottom by unlocking using key #711. Inside, the main PC, I/O and other components are located for easy access.
5. **TICKET MECH and OPTIONAL DBV DOOR:** With lock C582, this door opens using key #711. Inside, the Entropy ticket mechanism and ticket bin are located (when installed) or the service area and electrical connection for the optional bill acceptor is found just inside the door.
6. **LED LIGHTED AUDIO SPEAKERS (2)**
7. **COIN MECHANISM and COIN VAULT DOOR:** With lock C582, opens by key #711.
8. **LOCKING COIN BOX (INSIDE):** With lock C582, opens by key #711
9. **CONTROL PANEL CONSOLE:** Player's control panel- all game play functions, joystick and pushbuttons.

## 6-2 CONTROL PANEL CONSOLE

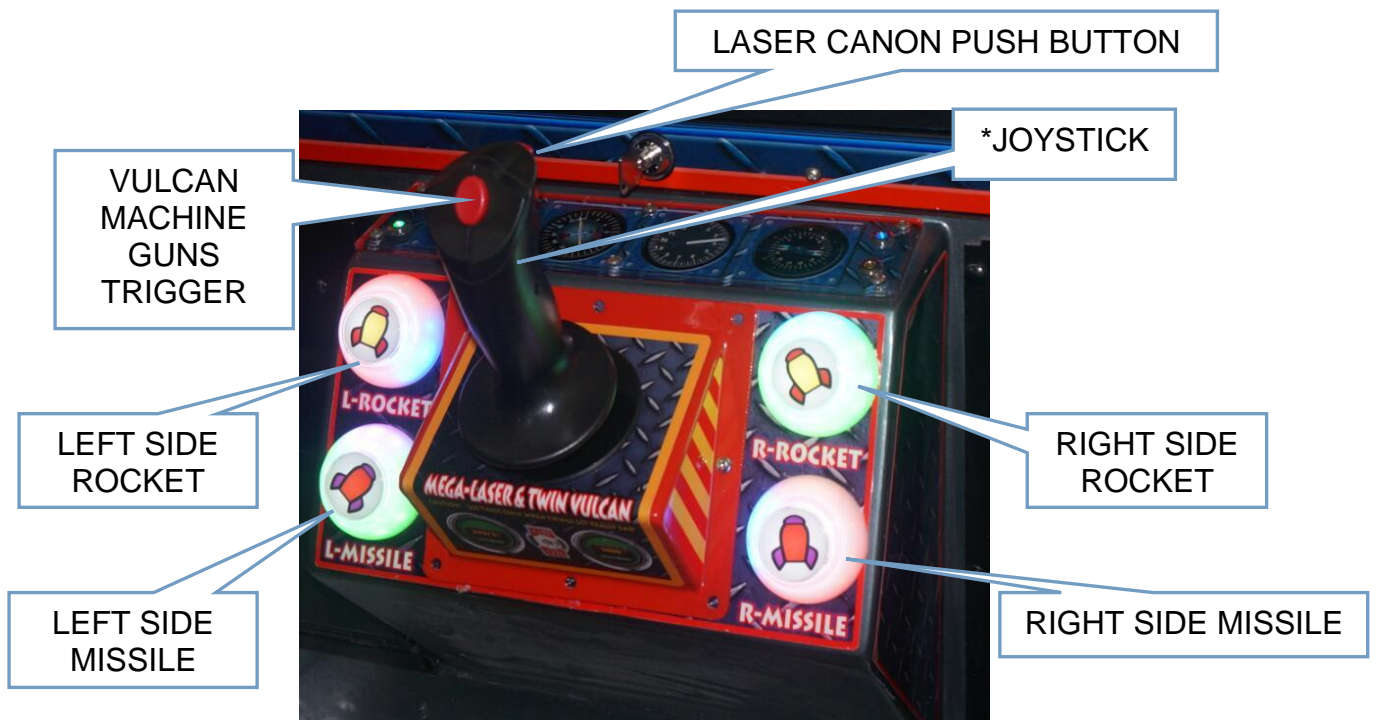

\*JOYSTICK: Controls the flight direction of "Big Bug Blaster". Also features the top pushbutton for firing the Laser Canon and pulling the trigger activates the twin Vulcan machine guns.

## 6-2 TICKET MECHANISM (ENTROPY)



### NOTE

For Ticket version only!

#### How to install the tickets;

Open the Ticket Door, place the Tickets into the TICKET HOLDER.

Feed the Tickets into the TICKET MECH.

- ① Unclip and remove the Ticket retainer

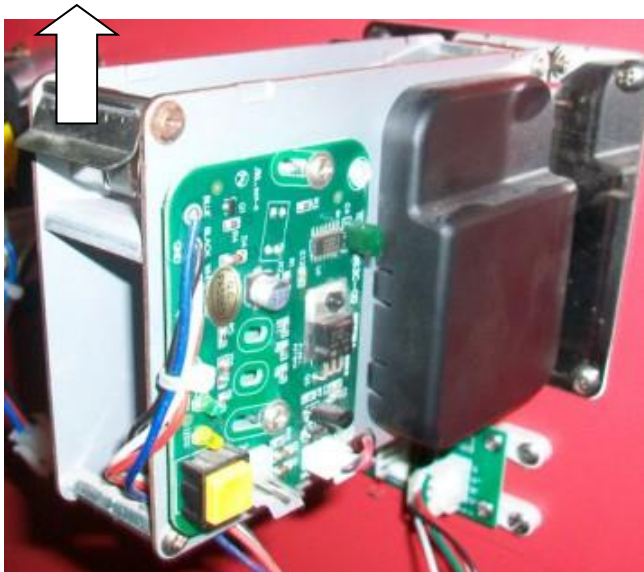

Picture 1

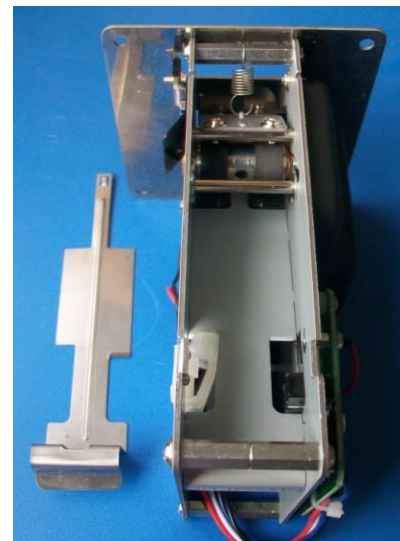

Picture 2

Feed the tickets into the mechanism making sure that the ticket passes through the sensor.



Replace the ticket retainer to secure tickets into position.

Press the square YELLOW TEST button on the PCB at the side of the mechanism to draw tickets through the mechanism and out of the ticket door.

Close the Ticket Door, tear off any excess tickets.

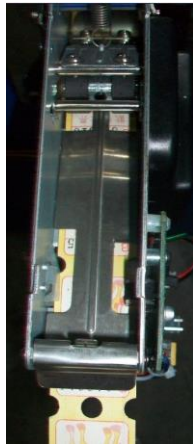

## 6-4 ELECTRONIC COIN MECH TW-130B

When coin selector rejects a coin, rotate the coin reject lever as picture, coin will reject. If coin does not reject, open the coin selector from inside to take out the faulty coin.

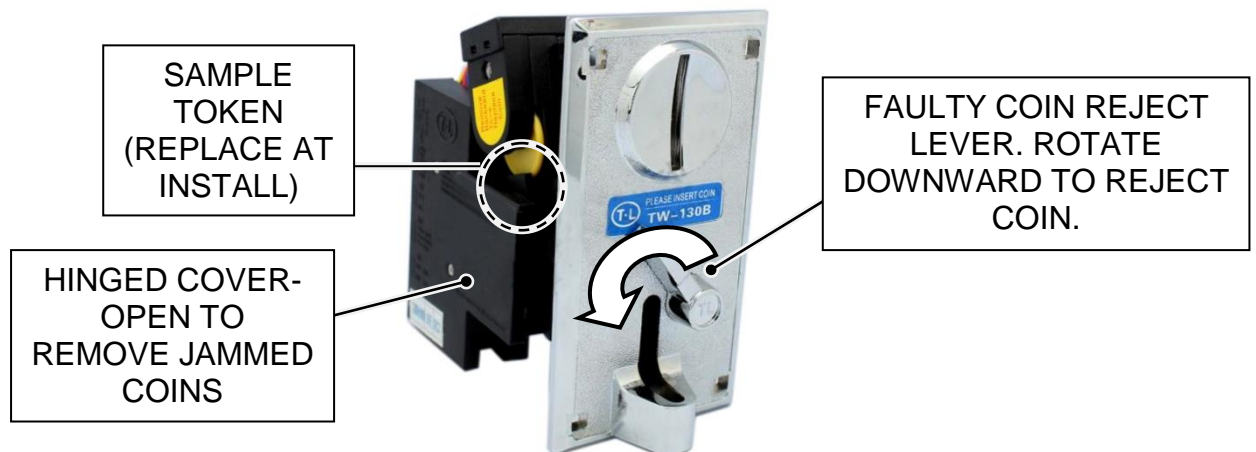

- ◆ Take out the plastic coin from coin slot, displace the proper coin
- ◆ **Hinged Cover:** Prevent coin blocked and convenient cleaning.
- ◆ **Coin diameter:** 20mm~30mm
- ◆ **Coin thickness:** 1.7mm ~2.4mm
- ◆ **Coin signal output:** O.C
- ◆ **Wire connection:**

- 1、 Grey and Red -DC+12V
- 2、 White -COIN signal

Code chart

- 3、 Black -Ground
- 4、 Grey

**Note:** Information subject to changes without notification.

## 6-6 HOST PC and I/O LOCATION ACCESS;

Host PC and I/O's position is behind the game monitor;



Open the monitor frame using key #711, Monitor will automatically raise up slowly by gas spring. Inside, you will find the Main PC and I/O as well as other components.



### ➤ HOST COMPUTER- BACK PANEL



- 1 POWER INLET
- 2 VGA
- 3 USB
- 4 NETWORK CONNECTION
- 5 USB (4)
- 6 AUDIO CONNECTION

## 7. CONTROL SIGNAL AND INSTRUCTION

### 7-1 PCB LAYOUT

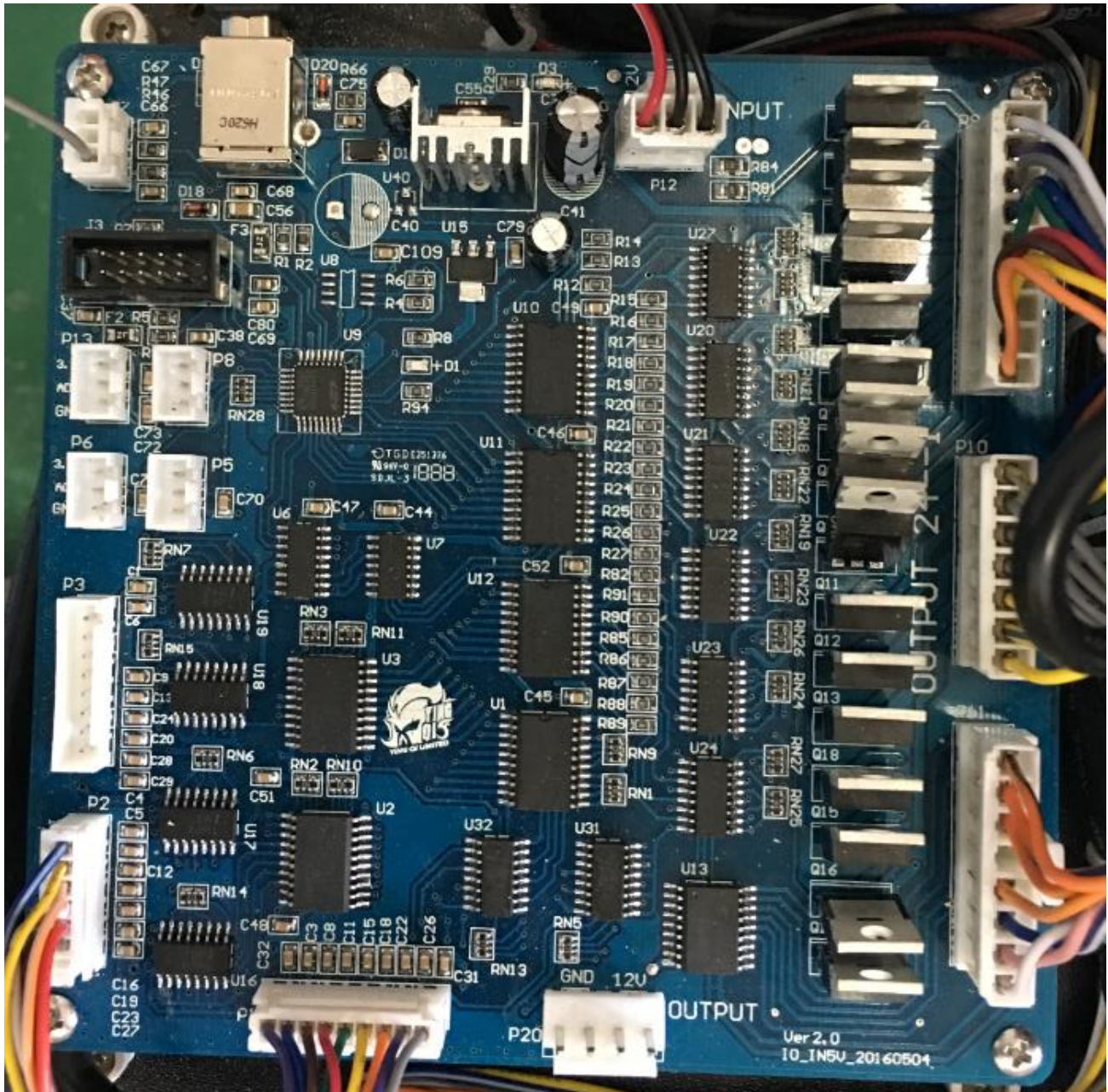

Wiring diagram follows on the next page;





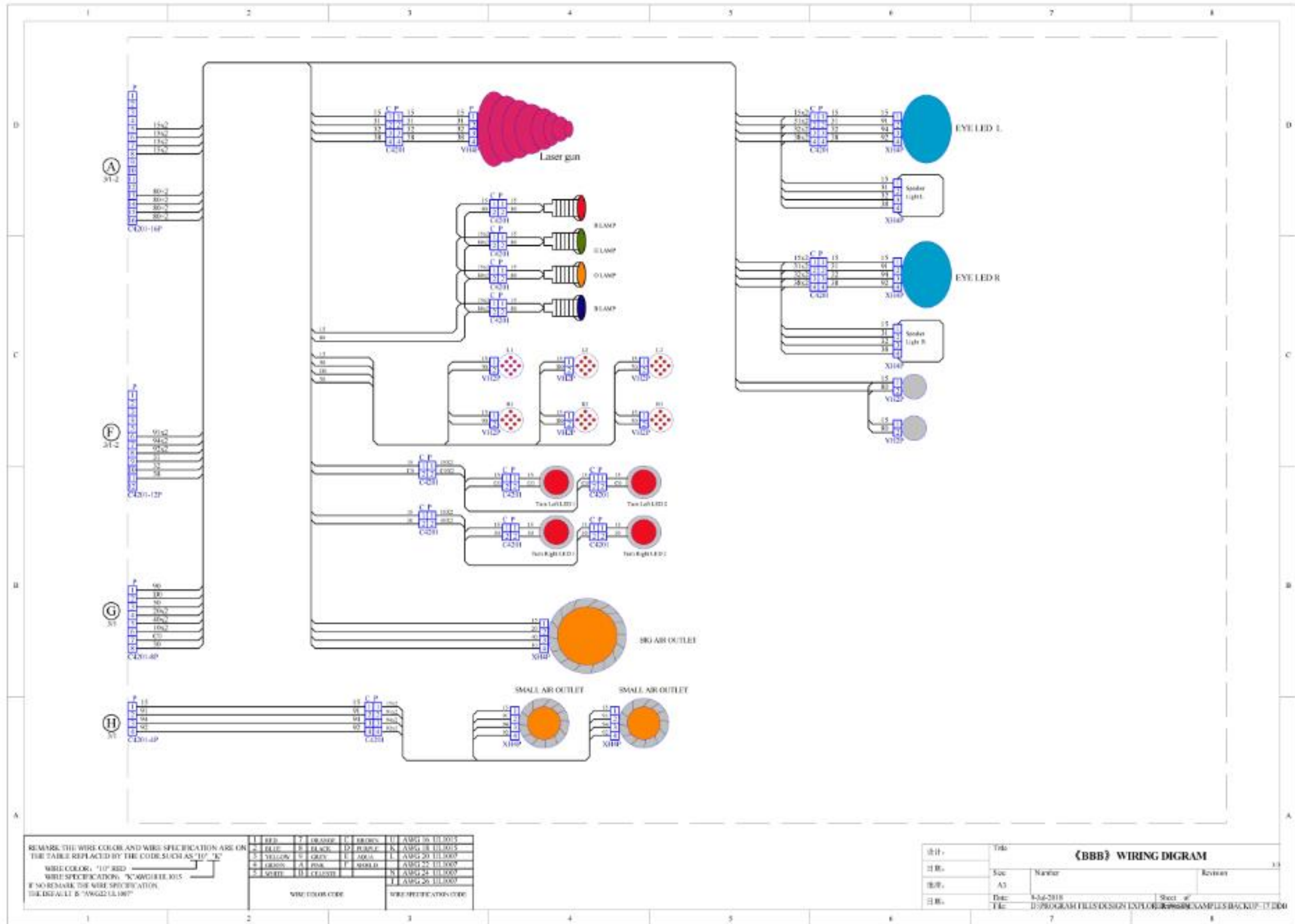

## 7-2 HOW TO ENTER INTO MENUS

Open the coin door and you will see the Setting/Meter Panel at the top of coin box;



To enter the Menu state on screen (ONLY during non-game play)- Press: "MENU" inside the door on this Setting/Meter panel, then you will see the information screen as below.



Figure 1

PRESS: "MENU" to advance through each setting. Then, "MENU" again for next screen.

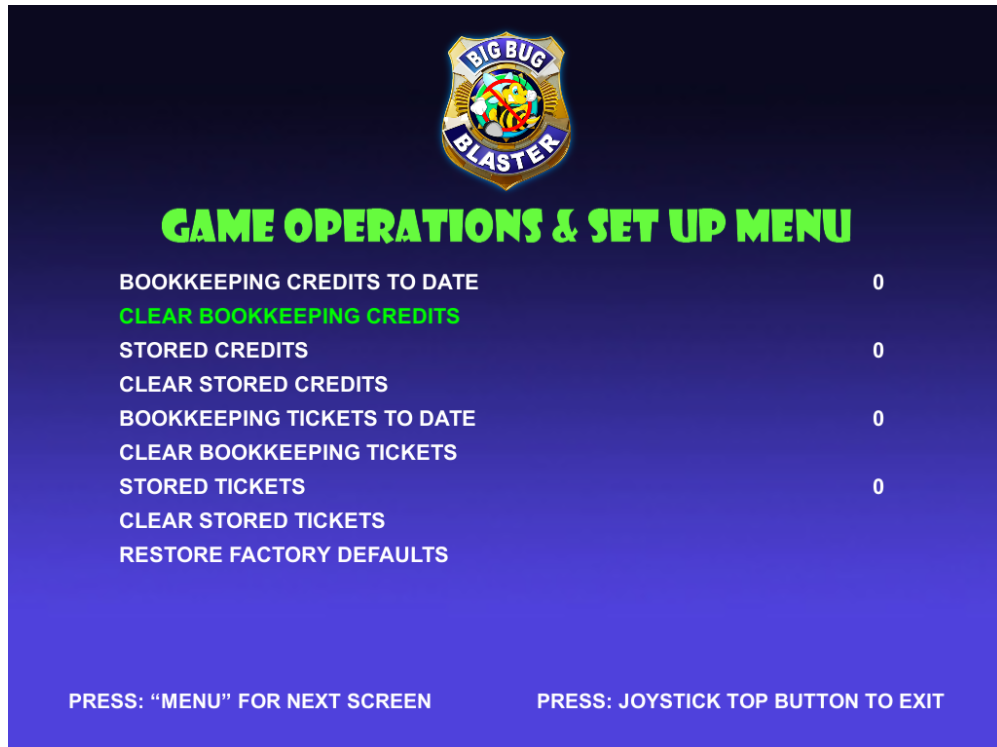

Figure 2

Press: "MENU" To advance through each setting. Press; "OPTION", to select and then choose; "YES or NO" to change. Pressing "MENU" again confirms the option and advances to next line. Press; "MENU" following last selection to advance to the next screen.

Press the joystick top button to exit and return to normal game play at any time.

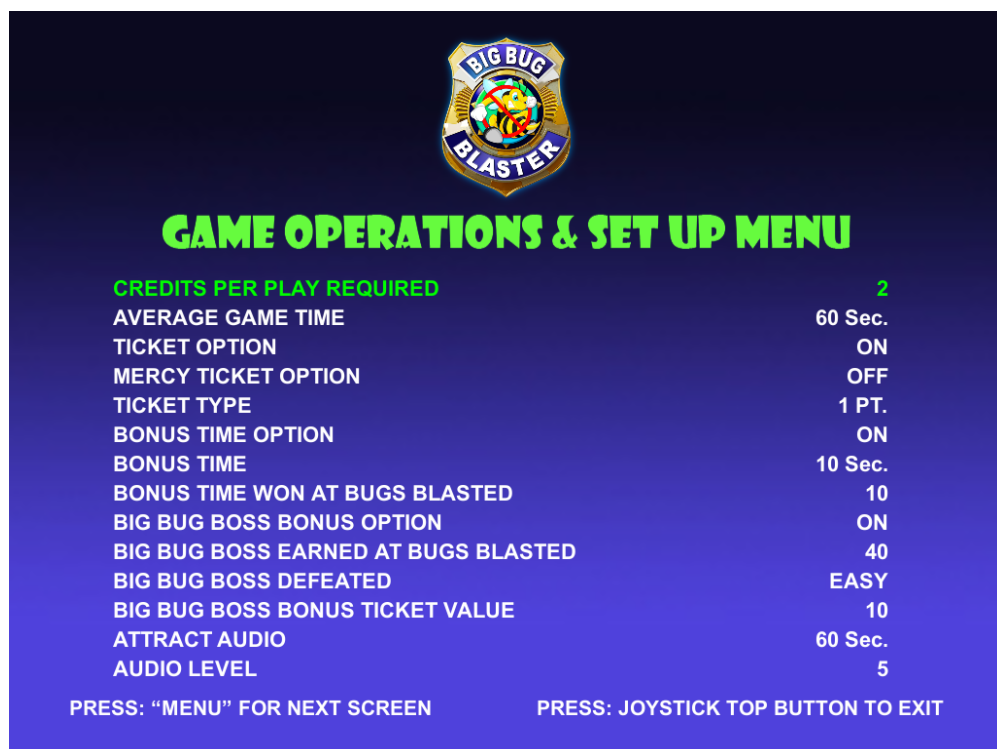

Figure 3

Press “OPTION” to modify parameter value, press; “MENU” to Select the next option:

CREDITS PER PLAY REQUIRED	1—8
AVERAGE GAME TIME	30 Sec—180 Sec
TICKET OPTION	ON/OFF
MERCY TICKET OPTION	0—8
TICKET TYPE	1PT/ 2PT
BONUS TIME OPTION	ON/OFF
BONUS TIME	5 Sec—30 Sec
BONUS TIME WON AT BUGS BLASTED	5—40
BIG BUG BOSS BONUS OPTION	ON/OFF
BIG BUG BOSS EARNED AT BUGS BLASTED	15—60
BIG BUG BOSS DEFEATED	EASY-HARD-HARDEST
BIG BUG BOSS BONUS TICKET VALUE	5—40
ATTRACT AUDIO	OFF/ 20—100
AUDIO LEVEL	1—10

Press the joystick top button to exit and return to normal game play at any time.

Press “OPTION” to Select the desired ticket payout level option .

**BIG BUG  
BLASTER**

## GAME OPERATIONS & SET UP MENU

WHEN THE TICKET OPTION IS ENABLED, THE FOLLOWING TICKET PAYOUT OPTIONS MAY BE SELECTED.  
TICKETS ARE DISPENSED FOR TOTAL NUMBER OF BUGS BLASTED AT THE END OF THE GAME.

TOTAL BUGS:	0-5	6-10	11-20	21-30	31-40	41-50
TICKET OPTION 1	0	1	2	3	4	5
TICKET OPTION 2	0	2	4	6	8	10
<b>TICKET OPTION 3</b>	<b>2</b>	<b>4</b>	<b>6</b>	<b>8</b>	<b>10</b>	<b>12</b>
TICKET OPTION 4	4	6	8	10	12	14
TICKET OPTION 5	6	8	10	12	16	24
TICKET OPTION 6	8	12	22	32	42	50

PRESS: “MENU” FOR NEXT SCREEN
PRESS: JOYSTICK TOP BUTTON TO EXIT

Figure 4

Figure 5 is the screen of “GAME TEST FUNCTIONS”

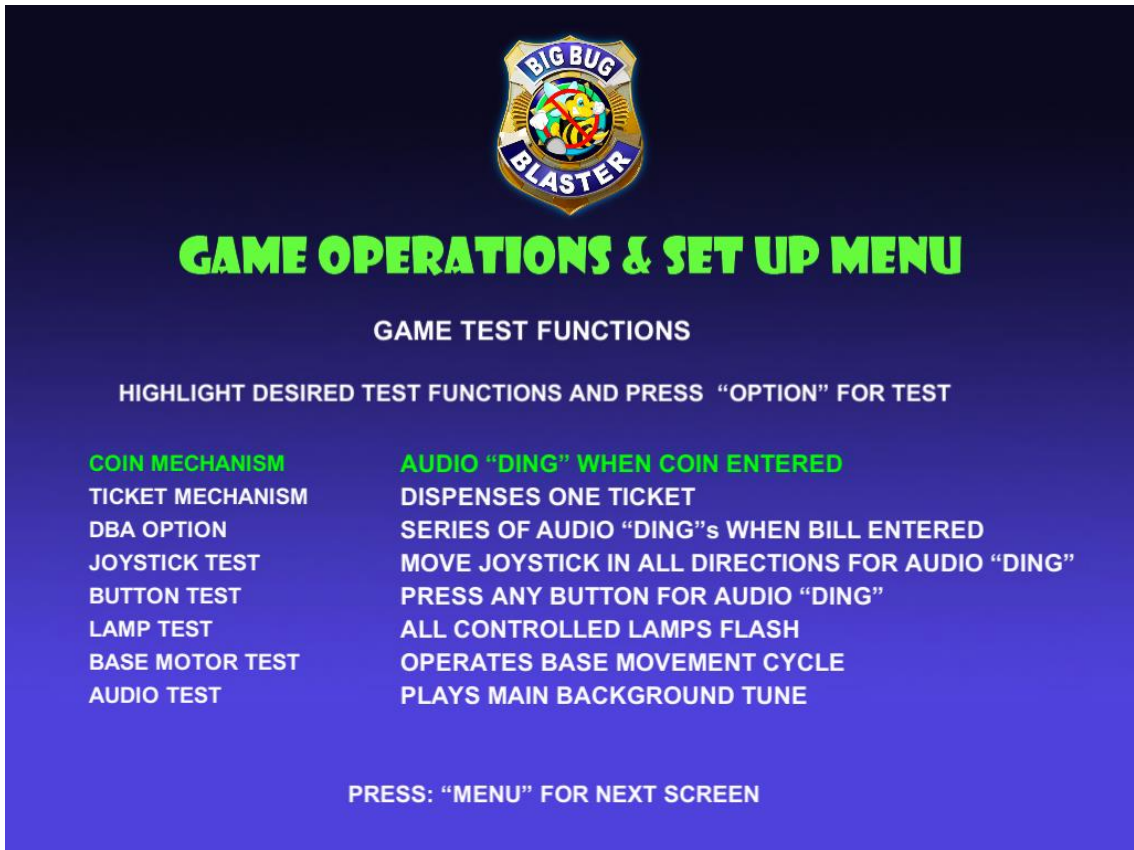

Figure 5

**TEST SCREEN NOTE!** - Press the joystick top button to exit and return to normal game play at any time EXCEPT in this test screen MENU since the top joystick button is also within the test functions. To exit the TEST screen, advance through the MENU list and enter the next page where you can exit the screen normally.

## 8. INSTRUCTION OF GAME PLAY



### 1. Game on screen interaction;



## 2. Game play START;

- 1、 Insert Credits required to start game play;



- 2、 Use the Joystick to move left, right, and forward. Press Joystick button to use Laser Canon



3、 Pull the Joystick trigger to fire the twin Vulcan machine guns. Use the control panel buttons to launch rockets and missiles;



4、 Blast big bugs as you fly through the city. By blasting (operator adjustable) levels of bugs, you can earn bonus time and points towards tickets (when enabled).



- 5、Blasting an operator adjustable number of bugs, the player can earn the chance to battle the “BIG BUG BOSS” level;



- 6、At “BIG BUG BOSS” level of play, the player is awarded 20 seconds of additional play time and an operator adjustable “BIG BUG BOSS” ticket award for beating the “BIG BUG BOSS”;



7、 Following the defeat of the “BIG BUG BOSS”, tickets are awarded (when enabled) and the GAME OVER sequence follows. Game over.



## 9. GENERAL TROUBLESHOOTING

Symptom	Possible Problem	Solution
	<b>POWER</b>	<b>POWER</b>
Sound Problems -No sound -Low Sound -Intermittent Sound	Low Volume  Faulty speaker harnessing  Faulty speaker Faulty sound board or sound board harnessing Faulty Main P.C. Board	Check Volume Control and adjust as necessary Check connections and/or repair harnessing Check and/or replace speaker Check connections or Replace Sound Board Check and/or repair or replace Main P.C. Board
Game does not take or credit money correctly	Coin switch out of adjustment Coin mech dirty or improperly adjusted Faulty Coin switch Faulty coin switch harness or connector Game improperly programmed Faulty Main P.C. Board or component	Re-form coin switch wire Clean and adjust mech as necessary Check and/or replace switch Check and/or repair harnessing Check programming options and adjust Repair and/or replace Main P.C. board

<p>Ticket Dispenser not working properly, or no tickets being dispensed</p>	<p>No tickets in the game                  Tickets jammed in dispenser                  Ticket dispenser sensor blocked with debris                  Poor connection on the ticket dispenser                  Game improperly programmed                  Faulty ticket dispenser                  Faulty ticket dispenser harnessing                  Faulty Main P.C. Board</p>	<p>Refill ticket dispenser                  Clear ticket jam                  Clean off sensor                    Check and/or replace connectors                  Check ticket programming options                  Replace dispenser                  Check and/or repair harnessing                  Replace or repair Main P.C. Board</p>
<p>LED Light fail</p>	<p>Poor contact of terminal                  LED light is burned out.                  No voltage output form power box</p>	<p>Correct the connection                  Replace the broken LED light with new one.                  Replace with new power box</p>
<p>Game will not start.</p>	<p>Game power off                  Electrical Power Switch Open                  Main fuse blown                  Power Supply problem or failure                    Faulty P.C. board or component</p>	<p>Check on/off switch and power cord                  Close Electrical Power Switch                  Check and/or replace fuse as necessary                  Check Power Supply output and connections                  Repair and/or replace main P.C. board</p>
<p>Game stops or is stopped with nothing displayed in video monitor</p>	<p>The power connector is disconnected.                  Possible faulty connection or short circuit.</p>	<p>Reconnect the connector securely.                  Check all circuitry for faulty connections or short circuits.</p>





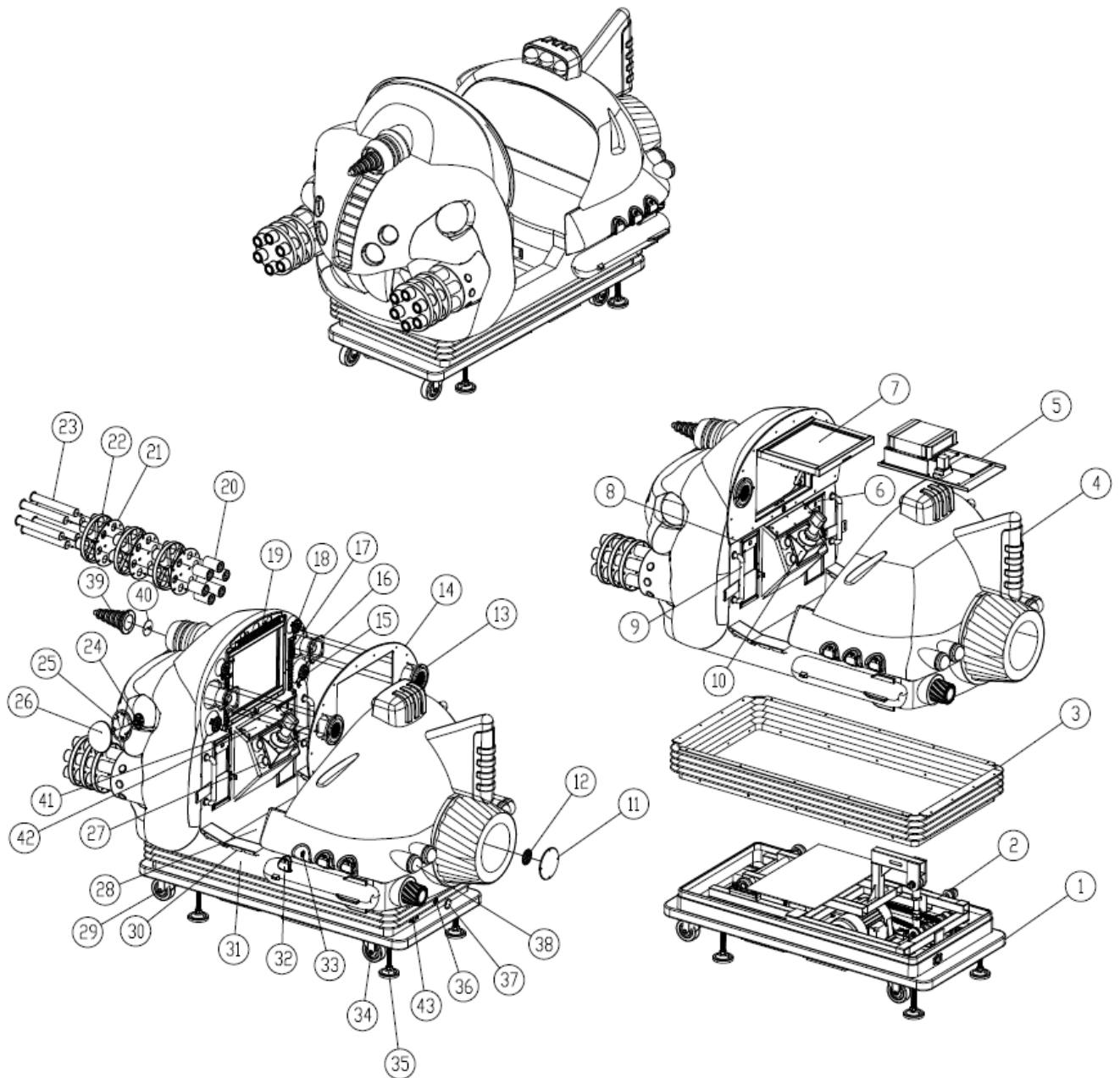





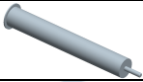





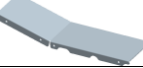

# 10. PART LIST

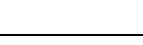

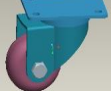

## 10-1 MAIN MECHANICAL LOCATION



NO.	PART CODE FOR BASE FRAME	DESCRIPTION	QTY	SPECIFICATION	IMAGES
1	BBB-1-01	BASE FRAME	1	FIBERGLASS	
2	BBB-1-02	UNDERFRAME	1	COMPONENT ASSY	
3	BBB-1-03	SKIRT	1	PVC	
4	BBB-1-04	FIBER GLASS	1	FIBER REINFORCE PLASTIC	

5	BBB-1-05	SET OF SOFTWARE,PC & I/O COMPONENT	1	COMPONENT ASSY	
6	BBB-1-06	COIN DOOR ASSEMBLY	1	COMPONENT ASSY	
7	BBB-1-07	MONITOR ASSEMBLY	1	COMPONENT ASSY	
8	BBB-1-08	TICKET DOOR and OPTIONAL DBV ASSEMBLY	1	COMPONENT ASSY	
9	BBB-1-09	HANDRAIL	2	SUS304	
10	BBB-1-10	JOYSTICK ASSEMBLY	1	COMPONENT ASSY	
11	BBB-1-11	LARGE EXHAUST LAMP COVER	1	PMMA DIFFUSER COVER	
12	BBB-1-12	RGB LIGHT BOARD	1	PCB	
13	BBB-1-13	SPEAKER COVER	2	CLEAR LED RING	
14	BBB-1-14	MONITOR'S FACE PLATE	1	SILK SCREENED ACRYLIC	
15	BBB-1-15	WHITE LED LIGHT BORAD	2	PCB	
16	BBB-1-16	SPEAKER	2	8 OHM, 5W	
17	BBB-1-17	T8 LED (5 SET)	2	PCB	
18	BBB-1-18	WHITE LED LIGHT BORAD	2	PCB	
19	BBB-1-19	T8 LED (8 SET)	1	PCB	
20	BBB-1-20	OUTSIDE BARRELS OF VULCAN GUN HEAD	12	WELD COMPONENT	
21	BBB-1-21	BACKING BOARD OF VULCAN GUN HEAD	6	BLACK ABS	
22	BBB-1-22	COVER OF VULCAN GUN HEAD	6	ELECTROPLATED ABS	

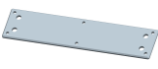

23	BBB-1-23	INSIDE TUBE OF VULCAN GUN HEAD	12	WELD COMPONENT	
24	BBB-1-24	RGB LIGHT BOARD	2	PCB	
25	BBB-1-25	EYE FASTENED PANEL	2	SPCC WHITE	
26	BBB-1-26	EYE COMPONENT	2	VACUUM FORMED ACRYLIC	
27	BBB-1-27	COLOR LED ROUND PUSHBUTTON	4	COMPONENT	
		<b>MICRO SWITCH</b>	4		
		<b>LED</b>	4	12V, 3W	
28	BBB-1-28	FLOOR PANEL	1	ALUMINIUM DIAMOND PLATE	
29	BBB-1-29	CASTERS (WITH BRAKING)	2	UNIVERSAL WHEEL(4 INCH)	
30	BBB-1-30	U -STYLE ALUMINIUM THRESHOLD PLATE	2	ALUMINIUM PLATE WITH DIAMOND PLATE PATTERN	
31L	BBB-1-31L	LEFT SIDE ALUMINIUM PLATE WITH DIAMOND PLATE PATTERN	1	ALUMINIUM PLATE WITH DIAMOND PLATE PATTERN	
31R	BBB-1-31R	RIGHT SIDE ALUMINIUM PLATE WITH DIAMOND PLATE PATTERN	1	ALUMINIUM PLATE WITH DIAMOND PLATE PATTERN	
32	BBB-1-32	SIDE LAMP COVER	6	PC RED TRANSLUCENT	
33	BBB-1-33	RED LED LIGHT BOARD FOR SIDE LAMP	6	PCB	
34	BBB-1-34	FIXED CASTER	2	UNIVERSAL WHEEL (4")	
35	BBB-1-35	ADJUSTER	4	M16 (HEIGHT 215	
36	BBB-1-36	RGB SMALL LIGHT BOARD	2	PCB	
37	BBB-1-37	SMALL EXHAUST LAMP COVER	2	PMMA DIFFUSER COVER	
38	BBB-1-38	BACK RED TAIL LAMP ASSY	4	DIRECTIONAL FLASHERS	
39	BBB-1-39	LASER GUN	1	PC MOLDED PART	

40	BBB-1-40	RGB LED BIG LIGHT BOARD	1	PCB	
41	BBB-1-41	FLASHING LIGHT(GREEN)	4	SMALL CONTROL PANEL FLASHING COLOR LEDs. EACH COLOR PER ONE PIECE	
		FLASHING LIGHT(RED)			
		FLASHING LIGHT(YELLOW)			
		FLASHING LIGHT(BLUE)			
42	BBB-1-42	ACRYLIC FOR CONTROL PANEL CONSOLE	1	PMMA SILKSCREEN	
43	BBB-1-43	POWER FILTER	1	FUSE 15A	

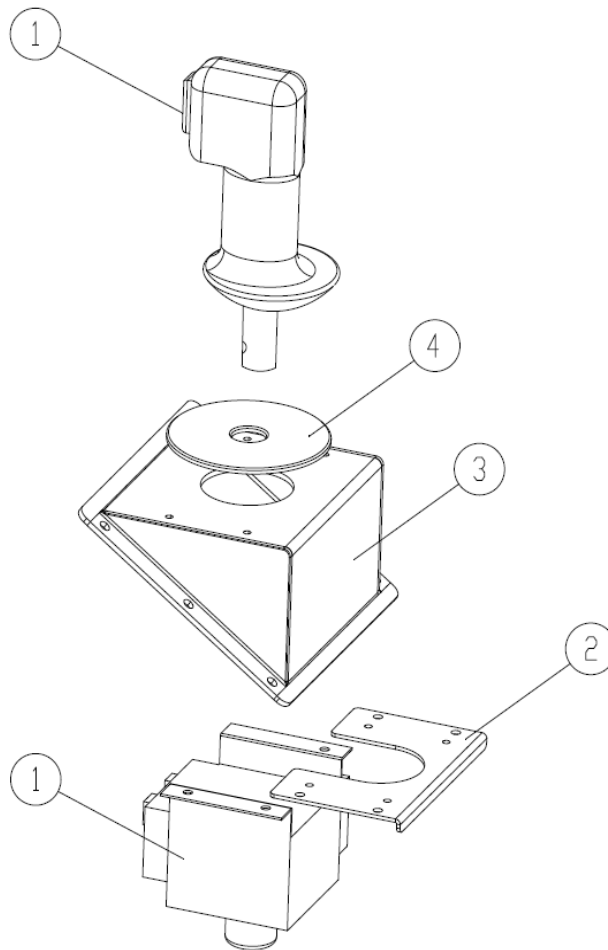
## 10-2 JOYSTICK COMPONENT

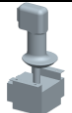

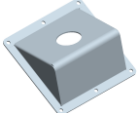





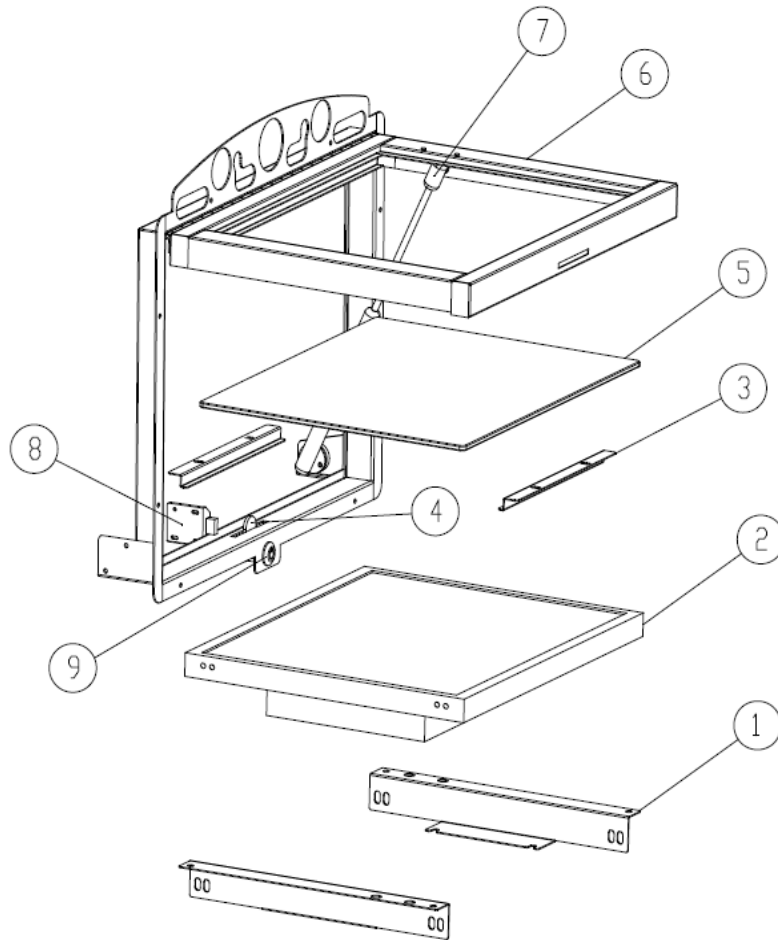

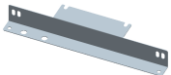
NO.	PART CODE FOR BASE FRAME	DESCRIPTION	QTY	SPECIFICATION/MATERIAL	IMAGES
1	BBB-2-01	4-WAY JOYSTICK	1	SPCC	

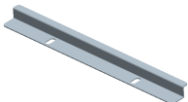
2	BBB-2-02	JOYSTICK BASE PANEL	1	SPCC	
3	BBB-2-03	JOYSTICK BASE ASSEMBLY	1	COMPONENT	
4	BBB-2-04	JOYSTICK BASE COVER PIECE	1	BLACK ABS	

### 10-3 MONITOR'S FRAME COMPONENT



NO.	PART CODE	DESCRIPTION	QTY	SPECIFICATION/ MATERIAL	IMAGES
1	BBB-3-01	MONITOR BRACKET	2	SECC	
2	BBB-3-02	MONITOR	1	17 寸 4:3/12V	
3	BBB-3-03	FASTEN PLATE FOR GLASS	2	SECC	



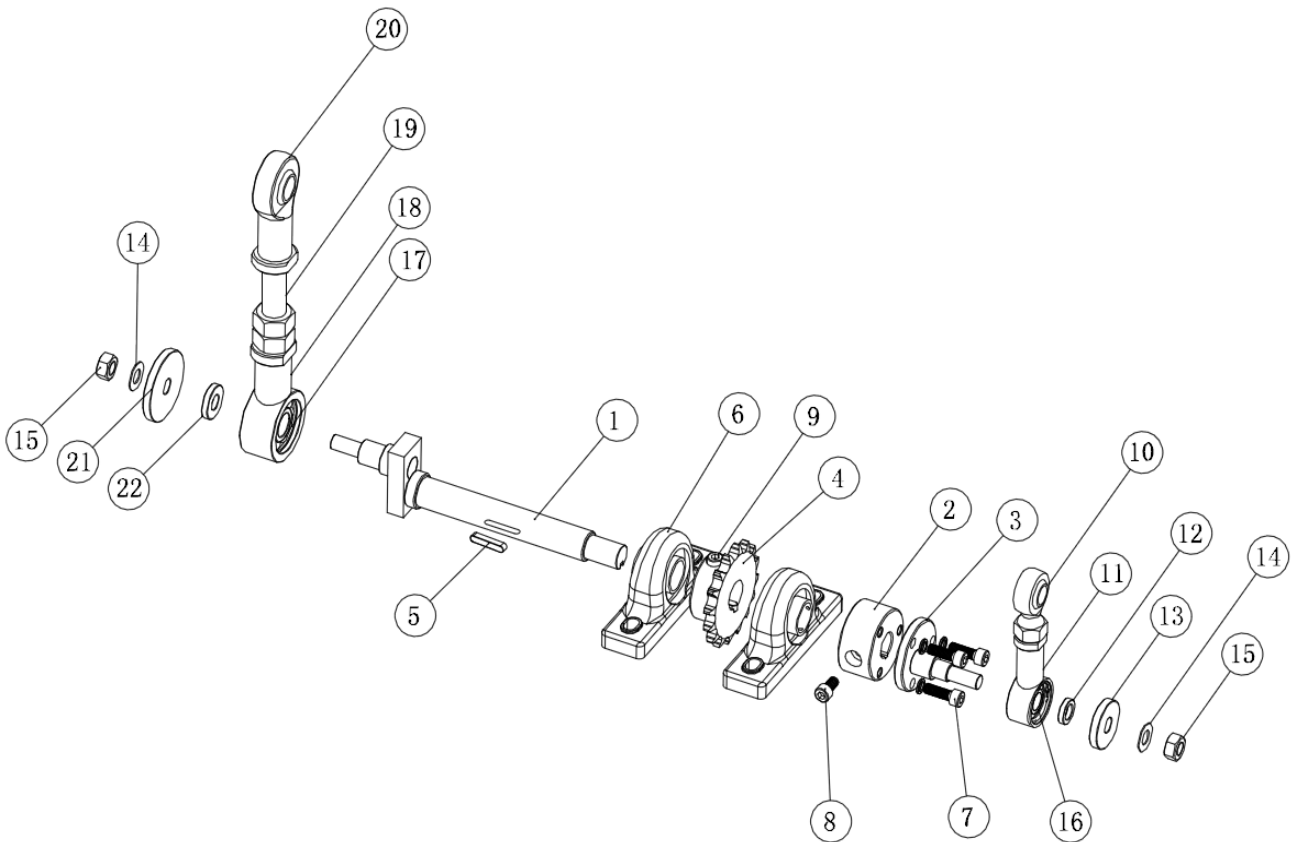

4	BBB-3-04	MONITOR FRAME ASSY LOCKING CAM	1	SUS304	
5	BBB-3-05	GLASS FOR MONITOR	1	TEMPERED GLASS	
6	BBB-3-06	MONITOR FRAME COVER	1	COMPONENT	
7	BBB-3-07	GAS OPERATED CYLINDER SPRING	1	120N	
8	BBB-3-08	SELF-LOCK/SELF-OPEN ASSY	1	33x58	
9	BBB-3-09	LOCK	1	THE LOCK NAMED C582 FOR THE KEY NAMED GU0711	

### 10-4 ECCENTRIC BEARING



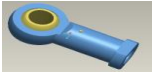

NO.	PART CODE	DESCRIPTION	QTY	SPECIFICATION/ MATERIAL	IMAGES
-----	-----------	-------------	-----	----------------------------	--------

1	BBB-4-01	DRIVE MOTION BEARING	1	Q235	
2	BBB-4-02	ECCENTRIC BLOCK A	1	Q235	
3	BBB-4-03	ECCENTRIC BLOCK B	1	Q235	
4	BBB-4-04	DRIVE CHAIN GEAR	1	45#	
5	BBB-4-05	FLAT KEY (A TYPE)	1	6X6X32	
6	BBB-4-06	UCP205 PILLOW BLOCK	2	UCP205	
7	BBB-4-07	SOCKET CAP SCREWS	3	M8X25	
8	BBB-4-08	SOCKET CAP SCREWS	1	M8X12	
9	BBB-4-09	SOCKET CAP SCREWS	1	M8X10	
10	BBB-4-10	MOTION LINKAGE JOINT BEARING (IN TEETH)	1	SOP16	
11	BBB-4-11	MOTION BEARING BUSHING B	1	Q235	
12	BBB-4-12	21 INNER WASHER	1	POM	
13	BBB-4-13	41 OUTER WASHER	1	POM	
14	BBB-4-14	FLAT WSHER	2	12X24X1.2	
15	BBB-4-15	NYLON LOCK NUT	2	M12	
16	BBB-4-16	2202 SELF-ALIGNING BALL BEARING	1	2202	
17	BBB-4-17	2304 SELF-ALIGNING BALL BEARING	1	2304	

18	BBB-4-18	MOTION BEARING BUSHING A	1	Q235	
19	BBB-4-19	PULL ROD	1	Q235	
20	BBB-4-20	MOTION LINKAGE JOINT BEARING (WITH GILB)	1	SOP20	
21	BBB-4-21	60 OUTER WASHER	1	POM	
22	BBB-4-22	29 INNER WASHER	1	POM	

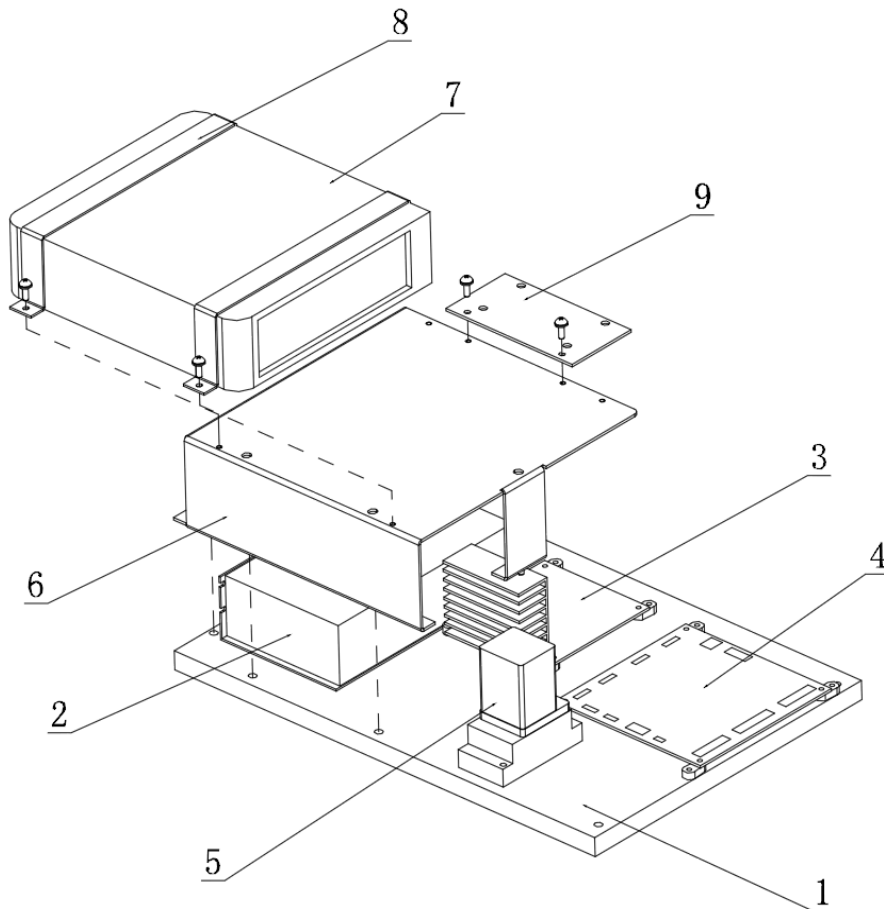
**10-5 SET OF SOFTWARE, MAIN PC and I/O COMPONENT**







NO.	PART CODE	DESCRIPTION	QTY	SPECIFICATION/ MATERIAL	IMAGES
1	BBB-5-01	ELECTRIC APPLIANCE INSTALL PLATE	1		

2	BBB-5-02	POWER SUPPLY	1	SP-150-12	
3	BBB-5-03	AMPLIFIER BOARD	1	GC-2.2	
4	BBB-5-04	IO BOARD	1		
5	BBB-5-05	RELAY	1	LJQX-38F/40A	
6	BBB-5-06	MAIN PC BOX HOLDER	1		
7	BBB-5-07	MAIN PC BOX	1		
8	BBB-5-08	FIXED BRACKET FOR MAIN PC BOX	2		
9	BBB-5-09	FIXED BLOCK FOR POWER SOURCE	1		

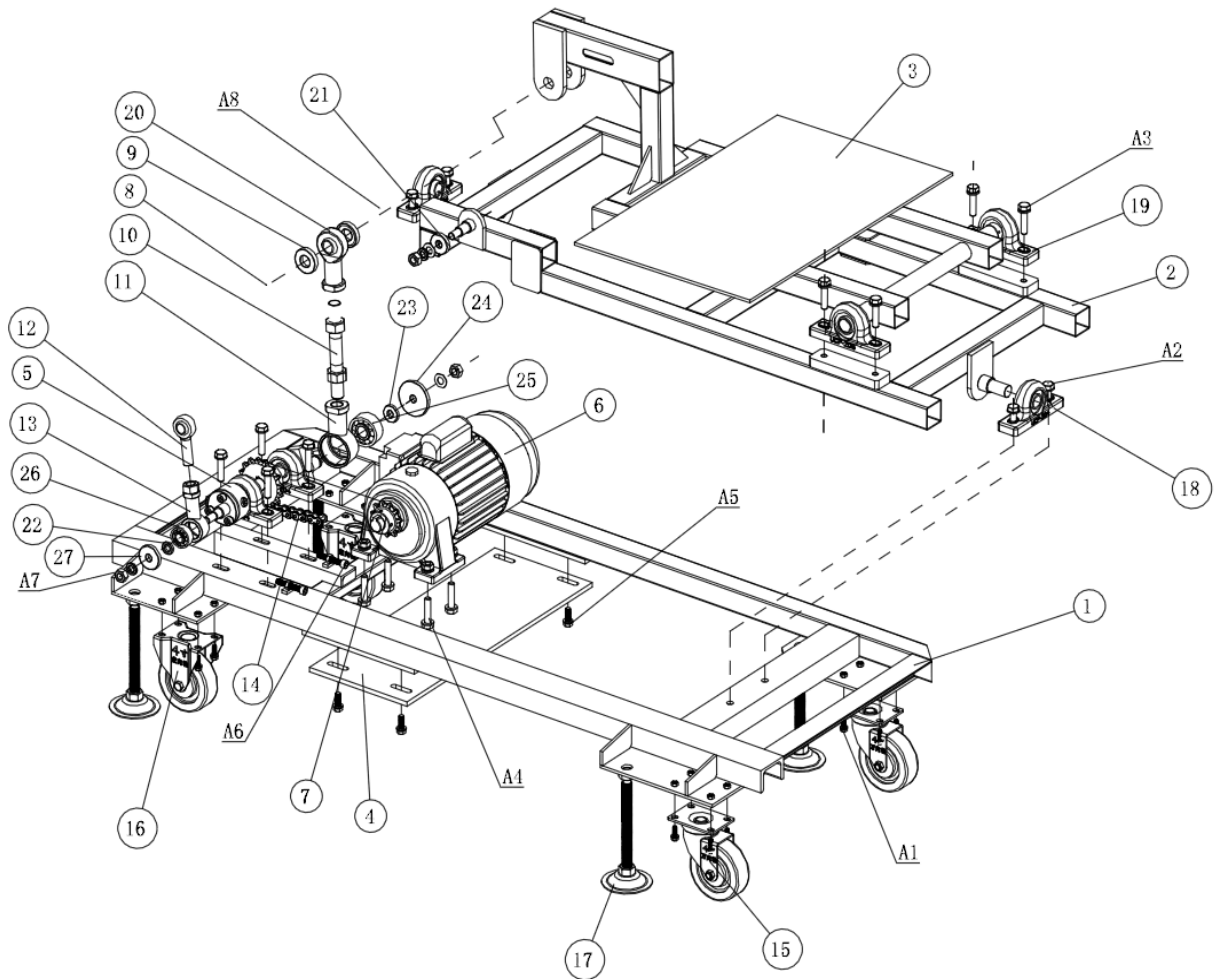
Continued on next page;

### 10-6 MECHANICAL BASE ASSEMBLY



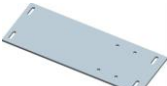











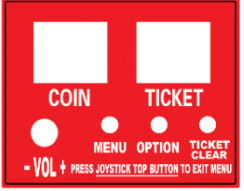

NO.	PART CODE	DESCRIPTION	QTY	SPECIFICATION/ MATERIAL	IMAGES
1	BBB-6-01	BOTTOM MOTION FRAME ASSY	1	Q235	
2	BBB-6-02	MAIN MOTION FRAME ASSY INCLUDING LEFT & RIGHT MOTION BRACKETS	1	Q235	
3	BBB-6-03	UPPER MOTION PLATE	1	Q235	
4	BBB-6-04	MOTOR BASE PLATE	1	Q235	

5	BBB-6-05	MOTION BEARING INSTALLMENT COMPONENT (COMPLETE DRIVE ASSY)	1		
6	BBB-6-06	MOTOR (110V400W)	1	110V400W	
7	BBB-6-07	MOTOR CHAIN DRIVE GEAR	1	45#	
8	BBB-6-08	HINGE PIN	1	Q235	
9	BBB-6-09	SLEEVE OF MOTION LINKAGE JOINT BEARING	1	Nylon	
10	BBB-6-10	PULL ROD	1	Q235	
11	BBB-6-11	MOTION BEARING BUSHING A	2	Q235	
12	BBB-6-12	MOTION LINKAGE JOINT BEARING(OUT TEETH M16)	1		
13	BBB-6-13	MOTION BEARING BUSHING B	1	Q235	
14	BBB-6-14	CHAIN (5 QUANTILE CHAIN )	1	23 JOINT	
		<b>CHAIN</b>	<b>1</b>		
15	BBB-6-15	UNIVERSAL CASTER (4")	2	REAR	
16	BBB-6-16	DIRECTIONAL CASTER (4")	2	FRONT	
17	BBB-6-17	ADJUSTER (LEVELER)	4		
		<b>ADJUSTER MAT</b>	4	YBJ-005-14	
18	BBB-6-18	PILLOW BLOCK (UCP204)	2	UCP204	

19	BBB-6-19	PILLOW BLOCK (UCP205)	4	UCP205	
20	BBB-6-20	MOTION LINKAGE JOINT BEARING (INNER TEETH M20)	1	SOP20	
21	BBB-6-21	SMALL WASHER FOR JOINT BEARING	1	NYLON	
22	BBB-6-22	21 INNER NYLON WASHER	1	POM YBJ-010-23	
23	BBB-6-23	29 INNER NYLON WASHER	1	POM YBJ-010-21	
24	BBB-6-24	60 OUTER NYLON WASHER	1	POM YBJ-010-22	
25	BBB-6-25	SELF-ALIGNING CAPTIVE BALL BEARING	1	2202	
26	BBB-6-26	SELF-ALIGNING CAPTIVE BALL BEARING	1	2304	
27	BBB-6-27	41 OUTER NYLON WASHER	1	POM YBJ-010-24	

### 10-7 GRAPHIC MATERIALS-DECALS & LABELS

NO.	PART CODE	DESCRIPTION	QTY	SPECIFICATION/ MATERIAL	IMAGES
1	BBB-7-01	Graphics on both sides of Control Panel	1	PP	
2	BBB-7-02	Graphics on joystick base	1	PP	
3	BBB-7-03	Graphics on missile	1	PP	
4	BBB-7-04	Graphics on Control Panel	1	PP	

5	BBB-7-05	Decals on body	1	Water Decal	
6	BBB-7-06	Decals on Tail Fin	1	Water Decal	
7	BBB-7-07	Graphics on Meter Panel	1	PP	
8	BBB-7-08	Warning Label 1	1	PP	
9	BBB-7-09	Warning Label 2	1	PP	
10	BBB-7-10	Voltage Label	1	PP	
11	BBB-7-11	Label on Ticket door	1	PP	
12	BBB-7-12	Laser Label (inside rear center port)	0.2		
13	BBB-7-13	UCL Label (at coin door)	1	PP	
14	BBB-7-14	12V Label (at DBV cable)	1	PP	
15	BBB-7-15	Serial and Rating Label	1	PP	

## 11. REMOVING THE FIBERGLASS BODY- (NOTE- This step requires two people)

The fiberglass body must be removed when servicing the swing mechanism of the base. The method to remove the body when necessary is as follows:

1. Turn the game on, and enter the MENU & OPTIONS screen by pressing the appropriate buttons on the meter panel inside the coin door. Scroll through the MENU items to show the TEST screen and activate the motor test. This will cycle the motor and while it is raised to the

highest point, disconnect the power turning the game OFF while the body is at the highest position. Raising the body to the highest point makes the swing mechanism swing to the highest point, which is convenient to remove the fixed screw between the fiberglass body and the swing mechanism.

2. With the power supply disconnected, open the monitor maintenance door, disassemble the power input wire connector and motor power connector, and keep the connector closest to the swing mechanism away from the PC, so as not to wind the wire when removing the fiberglass body.

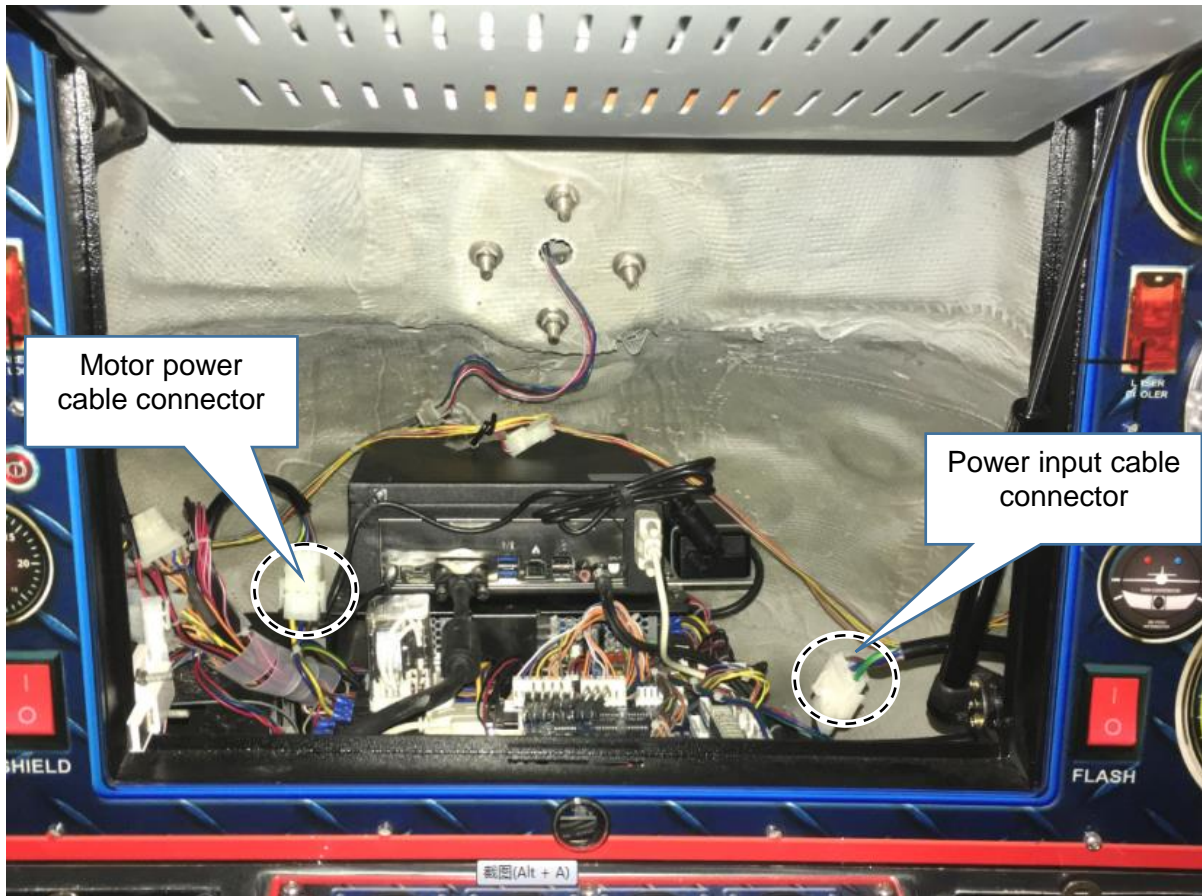

VIEWED THROUGH THE MONITOR DOOR ACCESS

3. Remove the screws attaching the skirt to the underside of the body (not the base) at all points along the connection between the fiberglass and the skirt, and press the skirt toward the base according to the crease in order to collapse it down.

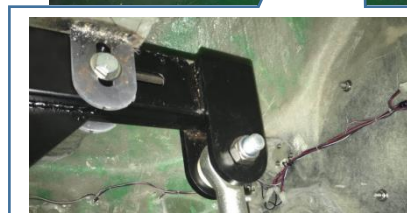
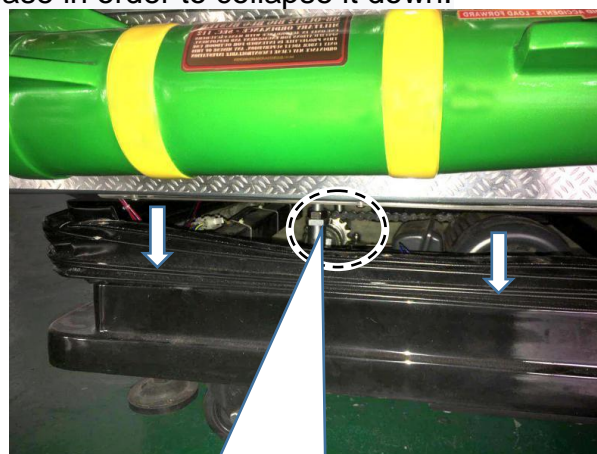

LOOK BETWEEN THE SKIRT AND BODY, BELOW THE SEAT, TO LOCATE THE RETAINING BOLT WHICH CONNECTS THE LONG DRIVE BEARING AND THE MOTOR TO THE UNDERSIDE OF THE

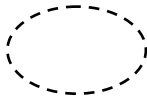

Loosen the retaining bolt and nut between the fiberglass and the swing mechanism (circled above).NOTE- **This step needs to be completed by two people!** Have someone slightly lift the body in order to take the weight of the body off the retaining bolt so that it can be removed easily.

4. On the inside floor of the ride, remove the 4 screws on the pedal position of the fiberglass (The circle below).

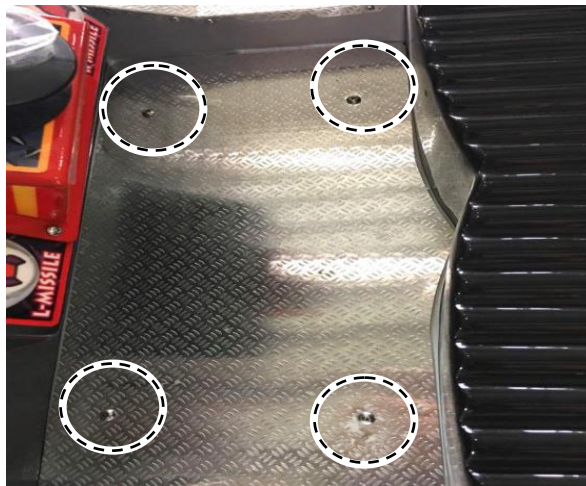

5. With two people lifting straight up slowly, lift the fiberglass body away. This step needs to be done by two people for personal and equipment safety. The swing mechanism can be found and easily accessed after the fiberglass body is removed.

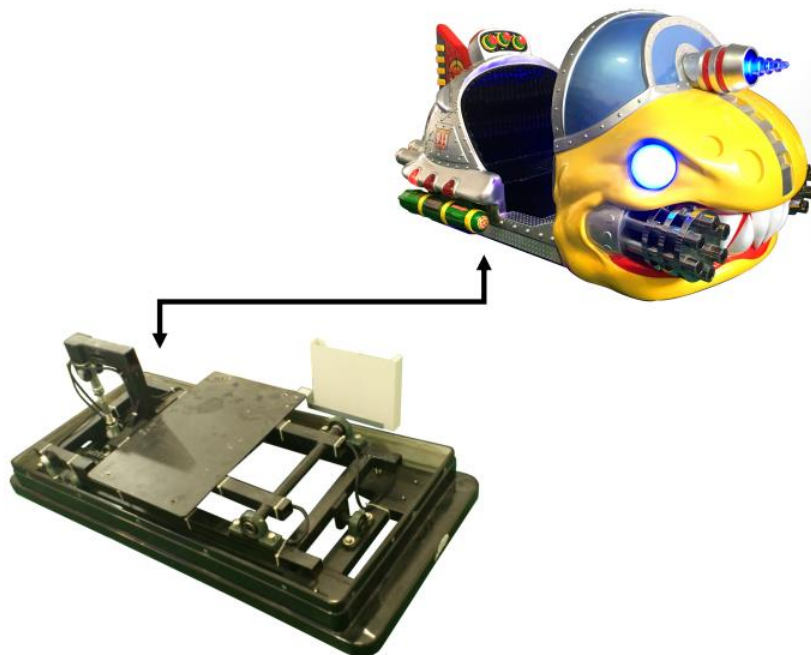

6. The swing mechanism can be checked, maintained and repaired after removing the fiberglass body. It is recommended to always properly grease the base mechanism using the zerk grease fittings at this time for easy access.

7. After finishing the inspection, maintenance and repair, install the machine in reverse order.

Continued on the next page;

⚠ Attention:

- Install the fiberglass body on the swing mechanism, aligning the position of the four screw holes inside the ride floor to the 4 holes in the swing base mechanism, making sure one hole is well aligned at first, and then drive the floor bolt down to make sure that the location is no longer offset, then rotating the body slightly to ensure proper alignment, insert and fasten the three remaining bolts.
- Be certain after complete installation and reassembly of the swing bearing below the seat, see that the power and motor connectors are connected properly behind the monitor. Check the motor test to move the ride and confirm everything has been properly reinstalled before reattaching the skirt between the base and the underside of the body.



STING INTERNATIONAL, P.O. BOX 455, ELK GROVE VILLAGE, IL 60009-0455 USA E-mail: [sting2 @ rcn.com](mailto:sting2@rcn.com).

**FOR ALL PARTS, SERVICE, AND TECHNICAL SUPPORT**  
**PHONE: 708-598-3720 FAX: 708-598-3720 [WWW.FAMILYFUNCOMPANIES.COM](http://WWW.FAMILYFUNCOMPANIES.COM)**

**STING INTERNATIONAL, © 2018 ALL RIGHTS RESERVED**